

### FEATURES

#### Precision power supply monitoring

#### 31 reset threshold options

1.58 V to 5.0 V

#### Four reset timeouts

1 ms, 20 ms, 140 ms, 1120 ms

#### Manual reset input

#### Reset output stage

Push-pull active-low

#### Guaranteed reset output valid to $V_{CC} = 1$ V

#### Power supply glitch immunity

#### Specified over $-40^{\circ}\text{C}$ to $+125^{\circ}\text{C}$ temperature range

#### 4-lead SC70 package

### APPLICATIONS

#### Microprocessor systems

#### Computers

#### Controllers

#### Intelligent instruments

#### Portable equipment

### GENERAL DESCRIPTION

The ADM6384 is a supervisory circuit that monitors power supply voltage levels in microprocessor-based systems. A power-on reset signal is generated when the supply voltage rises to a preset threshold level. The debounced manual reset input of the ADM6384 can be used to initiate a reset by means of an external push-button or logic signal.

The part is available in a choice of 31 reset threshold options, from 1.58 V to 5.0 V. The minimum reset timeout periods are 1 ms, 20 ms, 140 ms, and 1120 ms.

The ADM6384 is available in a 4-lead SC70 package and typically consumes only  $7\ \mu\text{A}$ , making it suitable for use in low power, portable applications.

### FUNCTIONAL BLOCK DIAGRAMS

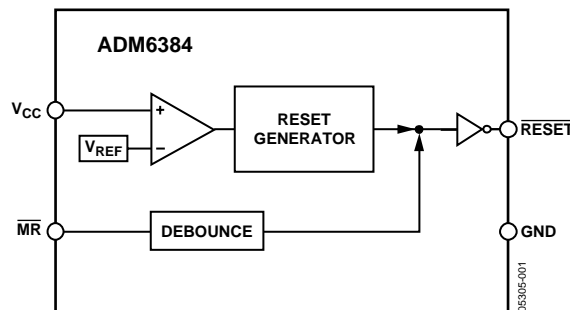

Figure 1.

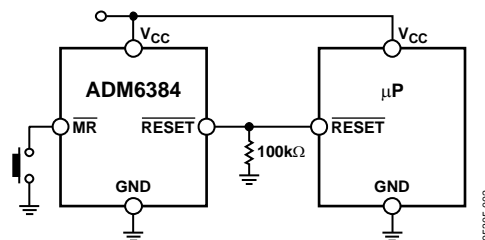

Figure 2.

#### Rev. 0

Information furnished by Analog Devices is believed to be accurate and reliable. However, no responsibility is assumed by Analog Devices for its use, nor for any infringements of patents or other rights of third parties that may result from its use. Specifications subject to change without notice. No license is granted by implication or otherwise under any patent or patent rights of Analog Devices. Trademarks and registered trademarks are the property of their respective owners.

## TABLE OF CONTENTS

Specifications.....	3	Manual Reset Input.....	9
Absolute Maximum Ratings.....	5	Application Information.....	10
ESD Caution.....	5	Negative-Going $V_{CC}$ Transients.....	10
Pin Configuration and Function Descriptions.....	6	Ensuring Reset Valid to $V_{CC} = 0\text{ V}$ .....	10
Typical Performance Characteristics.....	7	Outline Dimensions.....	11
Circuit Description.....	9	Ordering Guide.....	11
Reset Output.....	9		

## REVISION HISTORY

7/05—Revision 0: Initial Version

## SPECIFICATIONS

$V_{CC}$  = full operating range;  $T_A$  =  $-40^{\circ}\text{C}$  to  $+125^{\circ}\text{C}$ , unless otherwise noted.

Table 1.

Parameter	Min	Typ	Max	Unit	Test Conditions/Comments
<b>SUPPLY</b>					
$V_{CC}$ Operating Voltage Range	1		5.5	V	
Supply Current		7	13	$\mu\text{A}$	$V_{CC} = 5.5\text{ V}$ , no load
		6	11	$\mu\text{A}$	$V_{CC} = 3.6\text{ V}$ , no load
		4	7	$\mu\text{A}$	$V_{CC} = 2.5\text{ V}$ , no load <sup>1</sup>
		3	6	$\mu\text{A}$	$V_{CC} = 1.8\text{ V}$ , no load <sup>1</sup>
<b>RESET THRESHOLD VOLTAGE</b>					
ADM6384x50x	4.88	5.00	5.12	V	
ADM6384x49x	4.78	4.90	5.02	V	
ADM6384x48x	4.68	4.80	4.92	V	
ADM6384x47x	4.58	4.70	4.82	V	
ADM6384x46x	4.51	4.63	4.74	V	
ADM6384x45x	4.39	4.5	4.61	V	
ADM6384x44x	4.27	4.38	4.48	V	
ADM6384x43x	4.19	4.30	4.41	V	
ADM6384x42x	4.1	4.2	4.31	V	
ADM6384x41x	4.0	4.1	4.2	V	
ADM6384x40x	3.9	4.0	4.1	V	
ADM6384x39x	3.8	3.9	4.0	V	
ADM6384x38x	3.71	3.8	3.9	V	
ADM6384x37x	3.61	3.7	3.79	V	
ADM6384x36x	3.51	3.6	3.69	V	
ADM6384x35x	3.41	3.5	3.59	V	
ADM6384x34x	3.32	3.4	3.49	V	
ADM6384x33x	3.22	3.3	3.38	V	
ADM6384x32x	3.12	3.2	3.28	V	
ADM6384x31x	3.00	3.08	3.15	V	
ADM6384x30x	2.93	3.0	3.08	V	
ADM6384x29x	2.85	2.93	3.00	V	
ADM6384x28x	2.73	2.8	2.87	V	
ADM6384x27x	2.63	2.70	2.77	V	
ADM6384x26x	2.56	2.63	2.69	V	
ADM6384x25x	2.44	2.5	2.56	V	
ADM6384x24x	2.34	2.4	2.46	V	
ADM6384x23x	2.26	2.31	2.37	V	
ADM6384x22x	2.13	2.19	2.24	V	
ADM6384x17x	1.62	1.67	1.71	V	
ADM6384x16x	1.54	1.58	1.61	V	
<b>RESET THRESHOLD TEMPERATURE COEFFICIENT</b>					
		60		ppm/ $^{\circ}\text{C}$	
<b><math>V_{CC}</math> to RESET DELAY</b>					
		35		$\mu\text{s}$	$V_{CC}$ falling at $10\text{ mV}/\mu\text{s}$ from $V_{TH} + 100\text{ mV}$ to $V_{TH} - 100\text{ mV}$
<b>RESET THRESHOLD HYSTERESIS</b>					
		$2 \times V_{TH}$		mV	
<b>RESET TIMEOUT PERIOD</b>					
ADM6384xxD1	1		2	ms	
ADM6384xxD2	20		40	ms	
ADM6384xxD3	140		280	ms	
ADM6384xxD4	1120		2240	ms	

# ADM6384

Parameter	Min	Typ	Max	Unit	Test Conditions/Comments
MANUAL RESET INPUT					
$\overline{\text{MR}}$ Input Threshold					
$V_{\text{IL}}$			$0.3 \times V_{\text{CC}}$	V	$V_{\text{CC}} < 4 \text{ V}$
			0.8	V	$V_{\text{CC}} > 4 \text{ V}$
$V_{\text{IH}}$	$0.7 \times V_{\text{CC}}$			V	$V_{\text{CC}} < 4 \text{ V}$
	2.4			V	$V_{\text{CC}} > 4 \text{ V}$
$\overline{\text{MR}}$ Input Pulse Width	1			$\mu\text{s}$	
$\overline{\text{MR}}$ Glitch Rejection		100		ns	
$\overline{\text{MR}}$ Pull-Up Resistance	32	63	100	kV	
$\overline{\text{MR}}$ to Reset Delay		200		ns	
RESET Output Voltage					
$V_{\text{OL}}$			0.3	V	$V_{\text{CC}} \geq 1.0 \text{ V}, I_{\text{SINK}} = 80 \mu\text{A}$
			0.3	V	$V_{\text{CC}} \geq 2.5 \text{ V}, I_{\text{SINK}} = 1.2 \text{ mA}$
			0.4	V	$V_{\text{CC}} \geq 4.5 \text{ V}, I_{\text{SINK}} = 3.2 \text{ mA}$
$V_{\text{OH}}$	$0.8 \times V_{\text{CC}}$			V	$V_{\text{CC}} \geq 2.5 \text{ V}, I_{\text{SOURCE}} = 500 \mu\text{A}$
	$0.8 \times V_{\text{CC}}$			V	$V_{\text{CC}} \geq 4.5 \text{ V}, I_{\text{SOURCE}} = 800 \mu\text{A}$

<sup>1</sup>  $T_{\text{A}} = 25^{\circ}\text{C}$  only.

## ABSOLUTE MAXIMUM RATINGS

$T_A = 25^\circ\text{C}$ , unless otherwise noted.

**Table 2.**

Parameter	Rating
$V_{CC}$	-0.3 V to +6 V
$\overline{\text{RESET}}$	-0.3 V to +6 V
Output Current ( $\overline{\text{RESET}}$ )	20 mA
Operating Temperature Range	-40°C to +125°C
Storage Temperature Range	-65°C to +150°C
$\theta_{JA}$ Thermal Impedance, SC70	331°C/W
Soldering Temperature	
Sn/Pb	240°C, 30 sec
Pb-Free	260°C, 40 sec

Stresses above those listed under Absolute Maximum Ratings may cause permanent damage to the device. This is a stress rating only; functional operation of the device at these or any other conditions above those indicated in the operational section of this specification is not implied. Exposure to absolute maximum rating conditions for extended periods may affect device reliability.

### ESD CAUTION

ESD (electrostatic discharge) sensitive device. Electrostatic charges as high as 4000 V readily accumulate on the human body and test equipment and can discharge without detection. Although this product features proprietary ESD protection circuitry, permanent damage may occur on devices subjected to high energy electrostatic discharges. Therefore, proper ESD precautions are recommended to avoid performance degradation or loss of functionality.



# ADM6384

## PIN CONFIGURATION AND FUNCTION DESCRIPTIONS

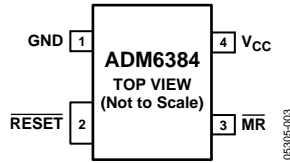

Figure 3. Pin Configuration

Table 3. Pin Function Descriptions

Pin No.	Name	Description
1	GND	Ground.
2	$\overline{\text{RESET}}$	Active-Low Reset Output. Asserted whenever $V_{CC}$ is below the reset threshold, $V_{TH}$ . Push-pull output stage.
3	$\overline{\text{MR}}$	Manual Reset Input. This is an active-low input which, when forced low for at least 1 $\mu\text{s}$ , generates a reset. It features a 52 kV internal pull-up.
4	$V_{CC}$	Power Supply Voltage Being Monitored.

# TYPICAL PERFORMANCE CHARACTERISTICS

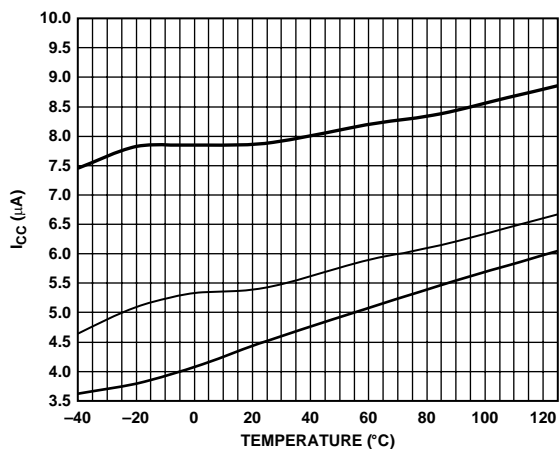

Figure 4. Supply Current vs. Temperature

04535-006

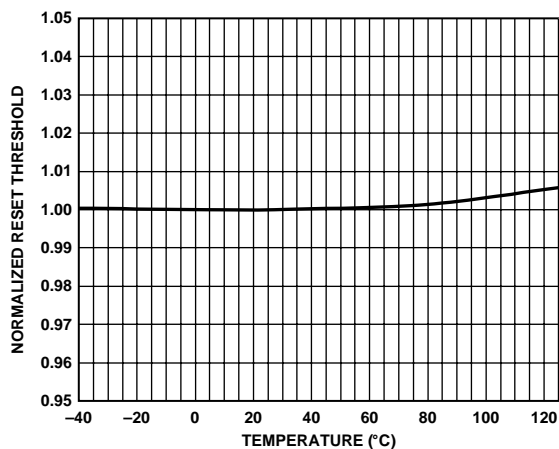

Figure 7. Normalized Reset Threshold vs. Temperature

04535-010

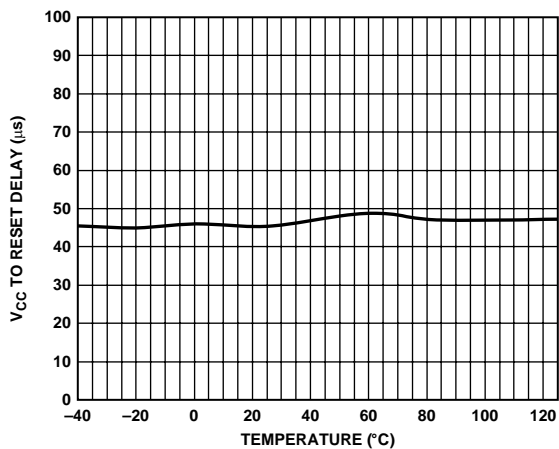

Figure 5. V<sub>CC</sub> to RESET Output Delay vs. Temperature

04535-008

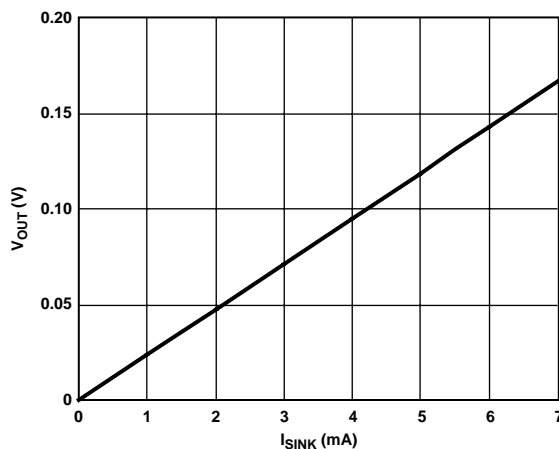

Figure 8. Output Voltage Low vs. I<sub>SINK</sub>

04535-017

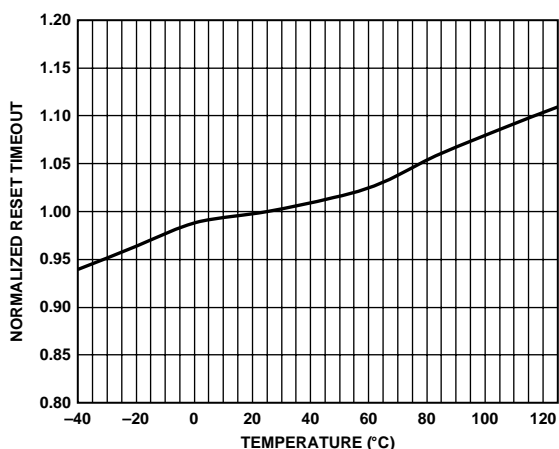

Figure 6. Normalized Reset Timeout Period vs. Temperature

04535-007

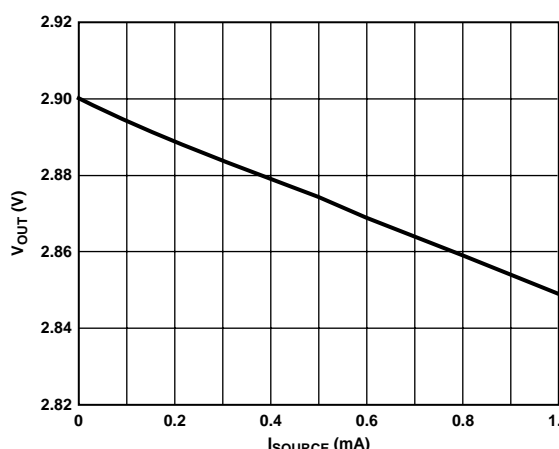

Figure 9. Output Voltage High vs. I<sub>SOURCE</sub>

04535-018

# ADM6384

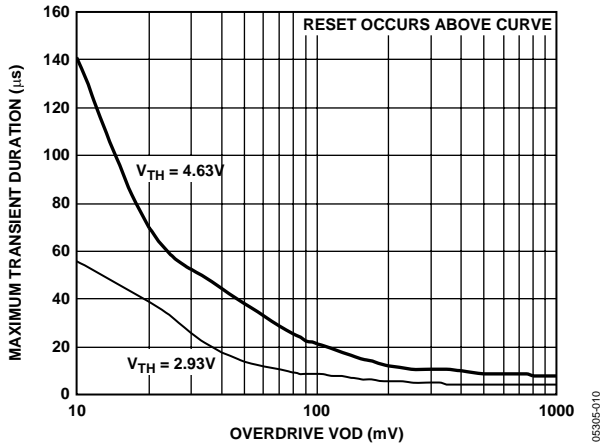

Figure 10. Maximum  $V_{CC}$  Transient Duration vs. Reset Threshold Overdrive

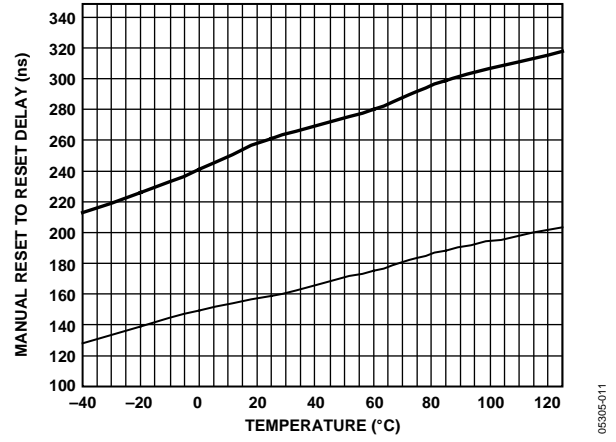

Figure 11. Manual Reset Minimum Pulse Width vs. Temperature



## CIRCUIT DESCRIPTION

The ADM6384 provides microprocessor supply voltage supervision by controlling the microprocessor's reset input. Code execution errors are avoided during power-up, power-down, and brownout conditions by asserting a reset signal when the supply voltage is below a preset threshold. In addition, the ADM6384 allows supply voltage stabilization with a fixed timeout before the reset deasserts after the supply voltage rises above the threshold. If the user detects a problem with the system's operation, a manual reset input is available to reset the microprocessor by means of an external push-button, for example.

### RESET OUTPUT

The ADM6384 features an active-low push-pull reset output. The reset signal is guaranteed to be logic low for  $V_{CC}$  down to 1 V.

The reset output is asserted when  $V_{CC}$  is below the reset threshold ( $V_{TH}$ ) or when  $\overline{MR}$  is driven low. Reset remains asserted for the duration of the reset active timeout period ( $t_{RP}$ ) after  $V_{CC}$  rises above the reset threshold or after  $\overline{MR}$  transitions from low to high. Figure 12 illustrates the behavior of the reset outputs.

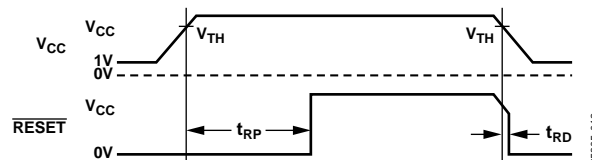

Figure 12. Reset Timing Diagram

### MANUAL RESET INPUT

The ADM6384 features a manual reset input ( $\overline{MR}$ ) which, when driven low, asserts the reset output. When  $\overline{MR}$  transitions from low to high, reset remains asserted for the duration of the reset active timeout period before deasserting. The  $\overline{MR}$  input has a 52 k $\Omega$  internal pull-up so that the input is always high when unconnected. An external push-button switch can be connected between  $\overline{MR}$  and ground so that the user can generate a reset. Debounce circuitry for this purpose is integrated on-chip. Noise immunity is provided on the  $\overline{MR}$  input, and fast, negative-going transients of up to 100 ns (typ) are ignored. A 0.1  $\mu$ F capacitor between  $\overline{MR}$  and ground provides additional noise immunity.

## APPLICATION INFORMATION

### NEGATIVE-GOING $V_{CC}$ TRANSIENTS

To avoid unnecessary resets caused by fast power supply transients, the ADM6384 is equipped with glitch rejection circuitry. The typical performance characteristic in Figure 10 plots  $V_{CC}$  transient duration versus the transient magnitude. The curves show combinations of transient magnitude and duration for which a reset is not generated for 4.63 V and 2.93 V reset threshold parts. For example, with the 2.93 V threshold, a transient that goes 100 mV below the threshold and lasts 8  $\mu$ s typically does not cause a reset, but if the transient is any bigger in magnitude or duration, a reset is generated. An optional 0.1  $\mu$ F bypass capacitor mounted close to  $V_{CC}$  provides additional glitch rejection.

### ENSURING RESET VALID TO $V_{CC} = 0$ V

Both active-low and active-high reset outputs are guaranteed to be valid for  $V_{CC}$  as low as 1 V. However, by using an external resistor with push-pull configured reset outputs, valid outputs for  $V_{CC}$  as low as 0 V are possible. For an active-low reset output, a resistor connected between  $\overline{\text{RESET}}$  and ground pulls the output low when it is unable to sink current. A large resistance such as 100 k $\Omega$  should be used so that it does not overload the reset output when  $V_{CC}$  is above 1 V.

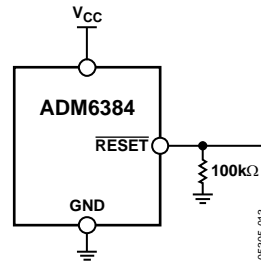
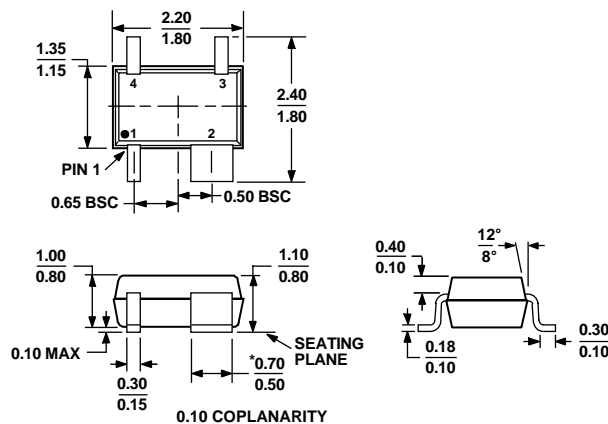

Figure 13. Ensuring Reset Valid to  $V_{CC} = 0$  V

# OUTLINE DIMENSIONS



\*PACKAGE OUTLINE CORRESPONDS IN FULL TO EIAJ SC82 EXCEPT FOR WIDTH OF PIN-2 AS SHOWN

Figure 14. 4-Lead Thin Shrink Small Outline Transistor Package [SC70] (KS-4)  
Dimensions shown in millimeters

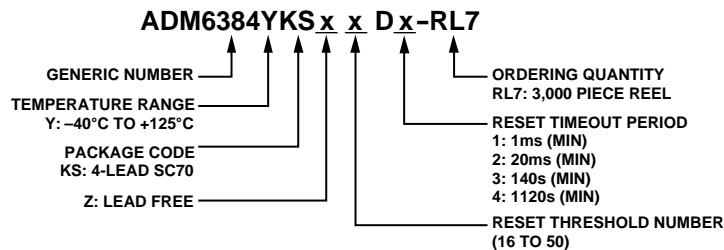

Figure 15. Ordering Code Structure

## ORDERING GUIDE

Standard Models <sup>1</sup>	Reset Threshold (V)	Reset Timeout (ms)	Temperature Range	Quantity	Package Type	Branding
ADM6384YKS29D1-RL7	2.93	1	-40°C to +125°C	3k	SC70-4	NOJ
ADM6384YKS23D3-RL7	2.31	140	-40°C to +125°C	3k	SC70-4	NOJ
ADM6384YKS29D3-RL7	2.93	140	-40°C to +125°C	3k	SC70-4	NOJ

<sup>1</sup> If ordering nonstandard models, complete the ordering code shown in Figure 15 by inserting reset timeout and reset threshold suffixes. Contact Sales for availability of nonstandard models.

**ADM6384**

**NOTES**